

OPERATIVA



ROMA



Leveza no design, detalhes de costura e recursos ergonômicos. A Roma é uma cadeira completa, em que o design e a funcionalidade andam de mãos dadas.

ROMA

A produtividade e a harmonia, características que a cadeira Roma proporciona para as áreas operativas, são fundamentais para um ambiente de trabalho. Atendendo às necessidades profissionais, esta cadeira garante ótimo grau de conforto ao usuário.

OPERATIVA

UM POUCO MAIS

Versão totalmente tapeçada, com 2 opções de tamanhos de espaldar (alto e médio) e apoio de cabeça opcional na versão alta



Duas opções de espaldar: médio e baixo. Dotado de sistema automático de regulação de altura para 12 posições



Versão fixa em 2 opções:
• estrutura tubular contínua;
• 4-pés (disponíveis apenas na versão totalmente tapeçada)





TÉCNICO



Mecanismo italiano

Com movimento de inclinação sincronizado entre assento e encosto. Possibilidade de 5 posições de bloqueio, regulagem de tensão do movimento e sistema anti-impacto (evita o movimento brusco contra as costas do usuário ao desbloquear a inclinação).



Mecanismo - DATTILO

Mecanismo com regulagem milimétrica de inclinação do encosto - conhecido como sistema de freio fricção ou contato permanente.

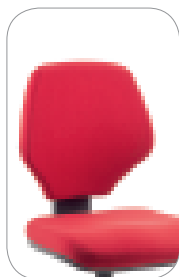
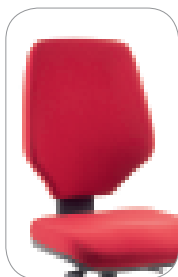
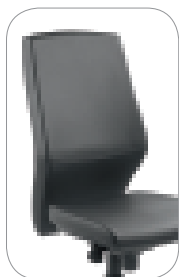

Encosto

Com regulagem automática de altura para as cadeiras giratórias. Acabamento da capa posterior em polipropileno.

Quatro opções de espaldar (alto e médio na versão tapeçada e médio e baixo na versão com capa em PP), oferecendo mais possibilidades para diferentes áreas e profissionais.

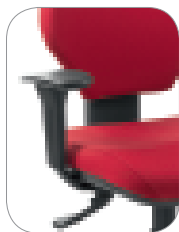

Apoia-braço (opcional)

Modelos fixos ou reguláveis com regulagem de altura, abertura e movimento angular.

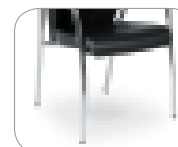

Estrutura fixa (opcional)

Opcional exclusivo para estrutura tubular fixa contínua, com duas opções de acabamento, cromada e preta.



Base

Base em alumínio injetado de alta resistência (acabamento polido) ou em poliamida injetada (resina termoplástica) na cor preta.



Rodízios

Com rodas duplas de 50 mm de diâmetro com opção de escolha para pisos acarpetados (tipo H) e pisos rígidos (tipo W).



Sapatas (opcional)

Injetadas em resina termoplástica na cor preta.

ACABAMENTOS

Tecidos / cores

LC - Lã Crepe

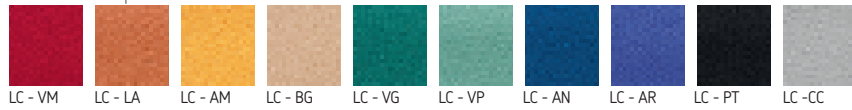

PE - Poliéster Elástico

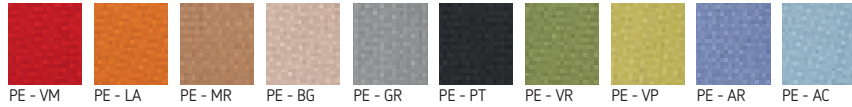

PC - Poliéster Crepe

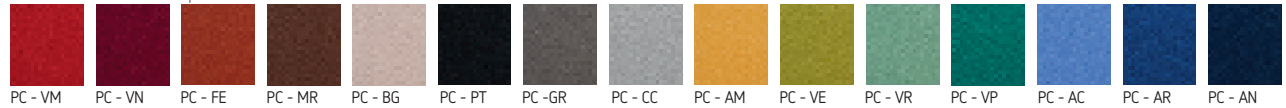

VF - PVC Flexleather

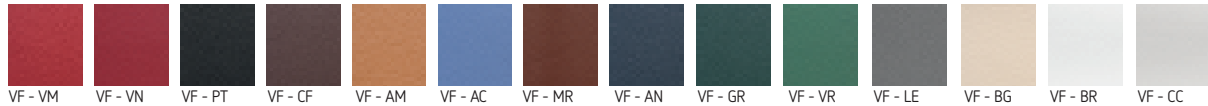

CN - Couro Natural

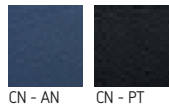

DIMENSÕES

ROMA ALTA COM APOIA CABEÇA
(TOTALMENTE TAPEÇADA)

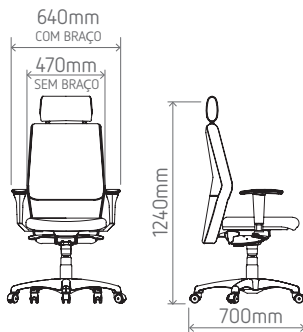

ROMA ALTA
(TOTALMENTE TAPEÇADA)

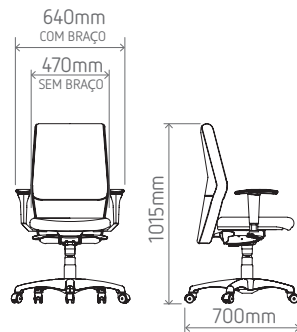

ROMA MÉDIA
(TOTALMENTE TAPEÇADA)

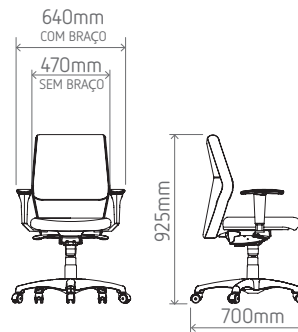

ROMA MÉDIA FIXA
(TOTALMENTE TAPEÇADA)

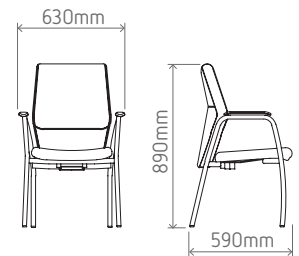

ROMA MÉDIA

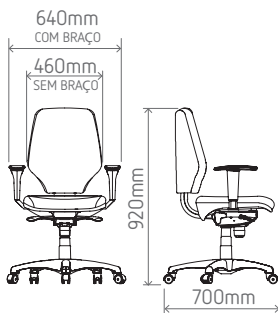

ROMA BAIXA

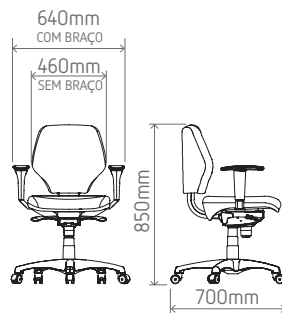

ROMA FIXA

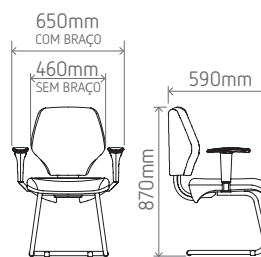



Flexform

Av. Papa João Paulo I, 1.849
Cumbica - Guarulhos - SP
CEP: 07170-350
Tel.: 55 11 3075-3455
flexform.com.br

Representante:

